

Data Sheet

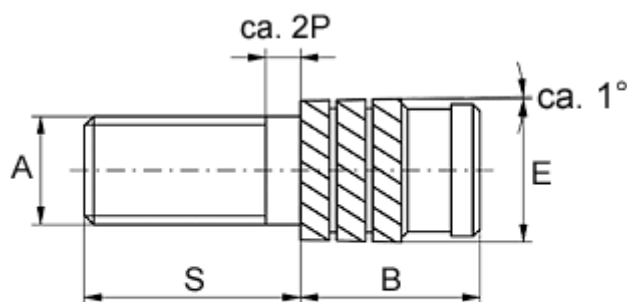

Article number: 12856000025860
Description: KLEE-coil 856 000 025.860
M2,5 Brass

Measures



Gevindlængde = $S - 2P$
P = stigning

Male thread A	= M2,5x0,45
Min distance to edge	= 2.0
Mounting length B	= 5.3
Outer diameter E	= 4.20
Pin length S	= 16
Recommended bore diameter	= 3.8
Type	= 856 000 025.860